

Pistola Automática New KHA 200

NEW

Especial alta produção







- Gaxeta da agulha em Carburo de Rulon.
- Bico+Agulha em aço inoxidável.
- Bico+Agulha em Carburo de Tungstênio (opcional).
- Inseto do corpo em aço inoxidável
- Tratamento da superfície Electroless Ni-P.

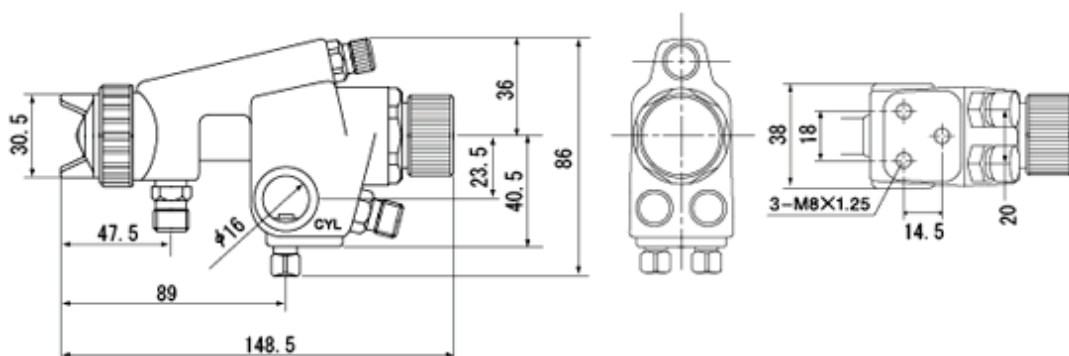

CE ϵ x II 2 G X

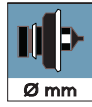

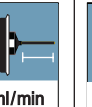
ESPECIFICAÇÕES TÉCNICAS

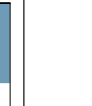
Model	 \varnothing mm	 bar	 NI/min	 ml/min	 mm	 No.	 g
KHA-200-10P	1.0	2.4	520	480	320	G2P	460
KHA-200-12P	1.2	2.4	540	500	320	G2P	460
KHA-200-15P	1.5	2.4	560	520	320	G2P	460

Max. Pressão Trabalho: 6.8 bar (98 PSI) Nível Ruído (L_{aeqT}): 76.3 dB (A)
 Temperatura: 5 ~ 40° C Nipple de Ar: G 1/4" Nipple Fluido: G1/4"

Fabricante Importador:

Distribuidor Exclusivo:



www.etk.com.br